

PRODUCT: ColorSpot 1200 AT		
TITLE: POWER BLOCK		
DOCUMENT: WIRING DIAGRAM		
VERSION: B	DATE: 6.11.2006	SHEET: 1 OF 8

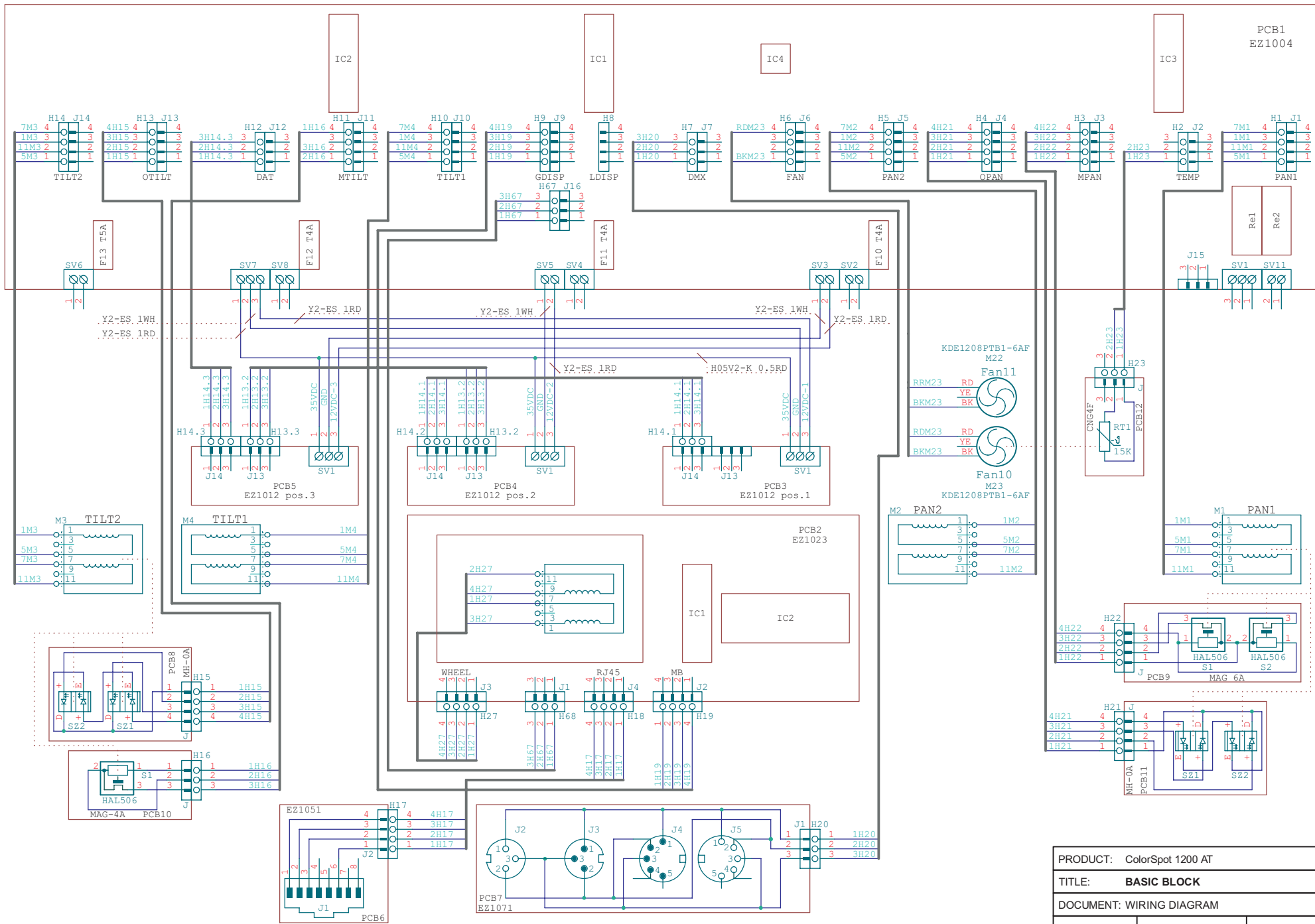

PRODUCT: ColorSpot 1200 AT		
TITLE: BASIC BLOCK		
DOCUMENT: WIRING DIAGRAM		
VERSION: B	DATE: 6.11.2006	SHEET: 2 OF 8

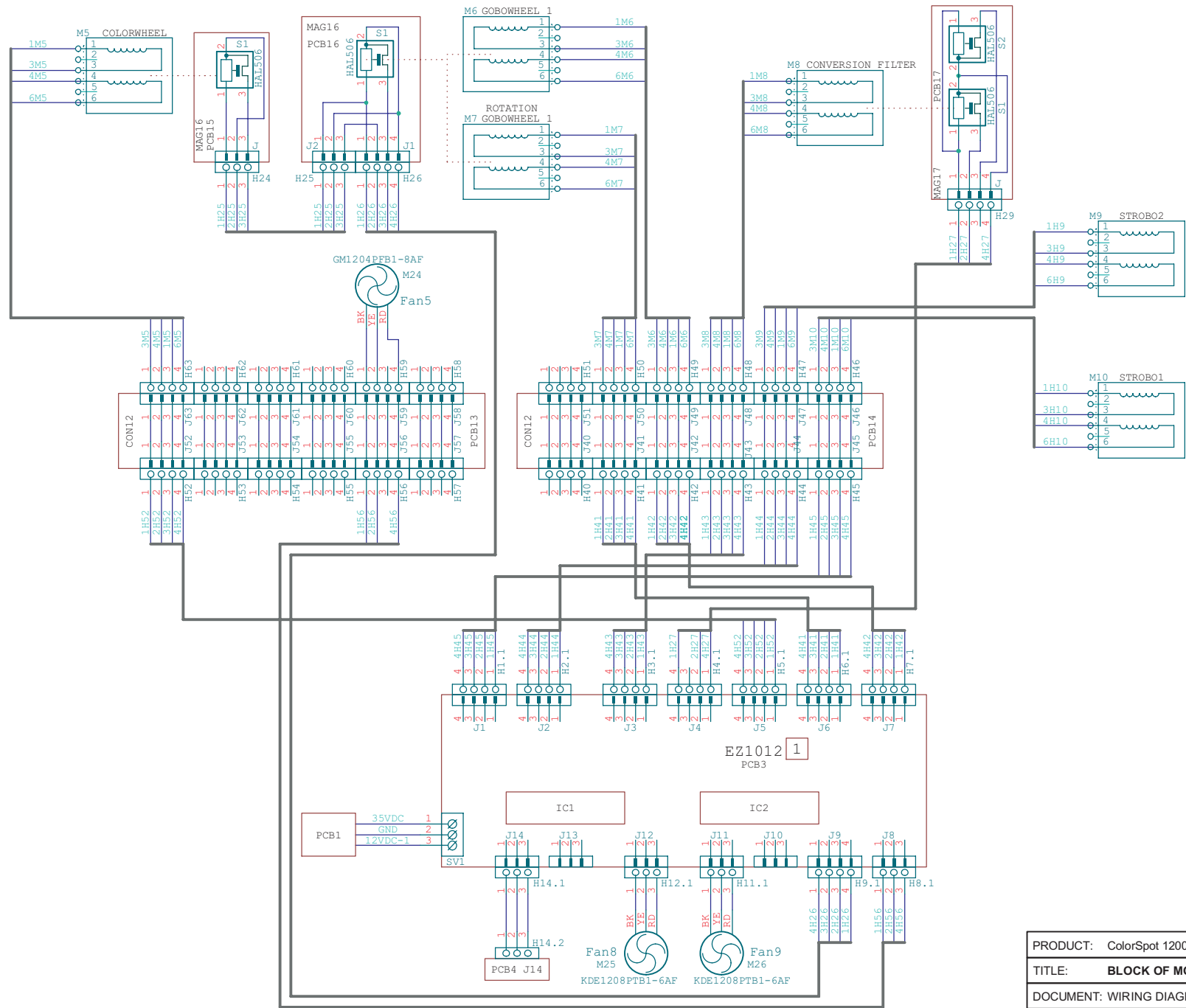

PRODUCT: ColorSpot 1200 AT		
TITLE: BLOCK OF MOTORS POS.1		
DOCUMENT: WIRING DIAGRAM		
VERSION: B	DATE: 6.11.2006	SHEET: 3 OF 8

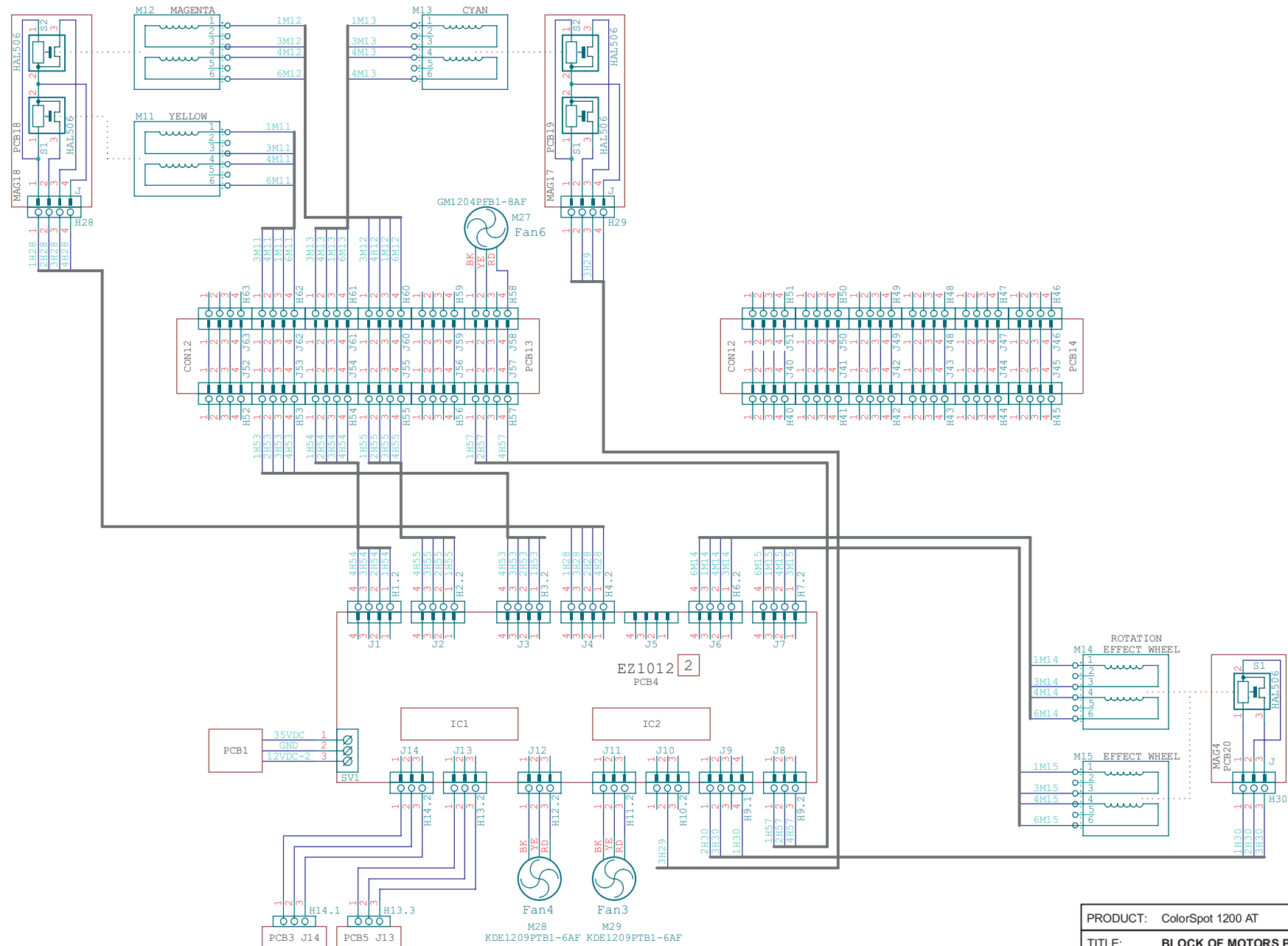

PRODUCT: ColorSpot 1200 AT		
TITLE: BLOCK OF MOTORS POS.2		
DOCUMENT: WIRING DIAGRAM		
VERSION: B	DATE: 6.11.2006	SHEET: 4 OF 8

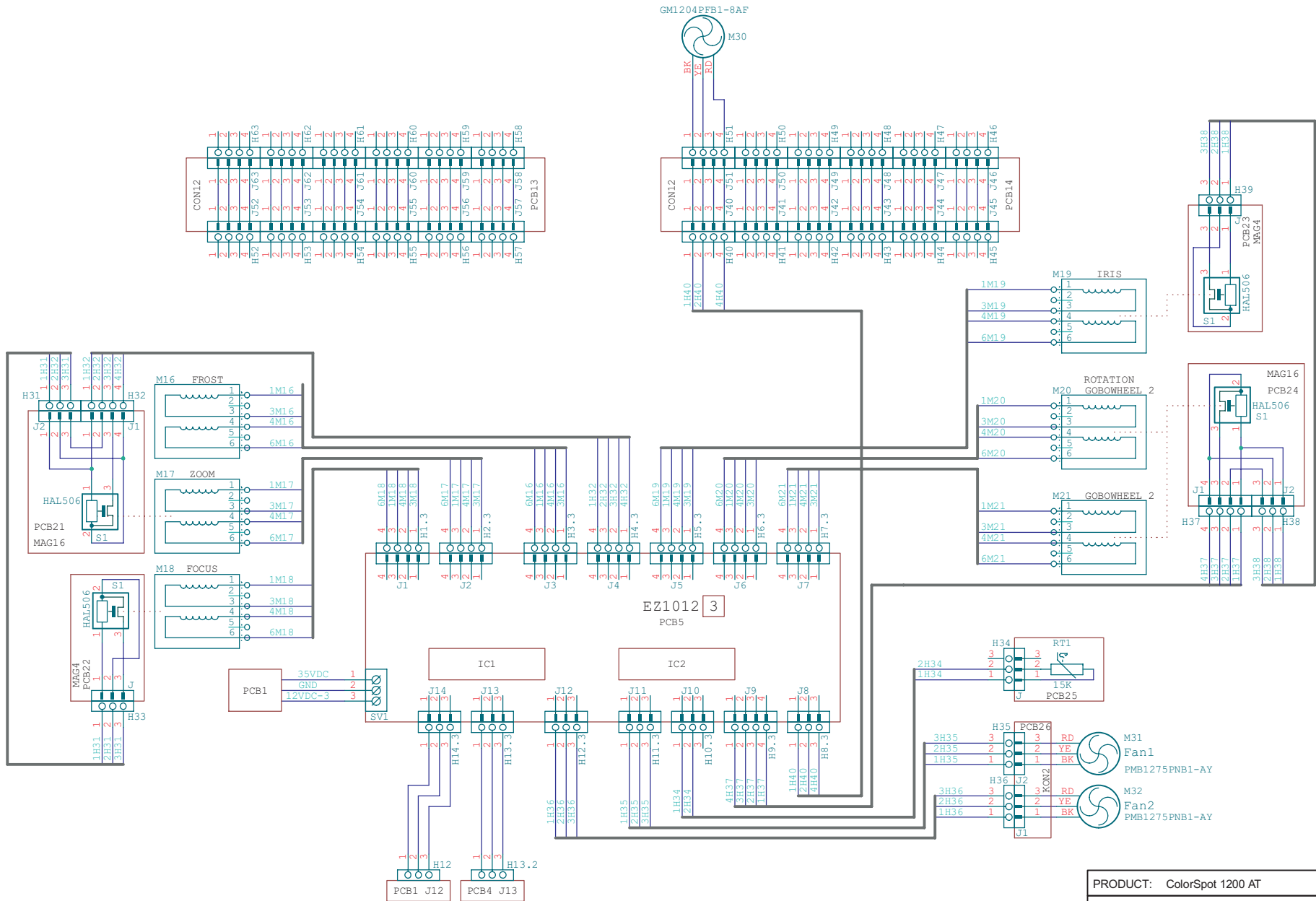

PRODUCT: ColorSpot 1200 AT		
TITLE: BLOCK OF MOTORS POS.3		
DOCUMENT: WIRING DIAGRAM		
VERSION: B	DATE: 6.11.2006	SHEET: 5 OF 8

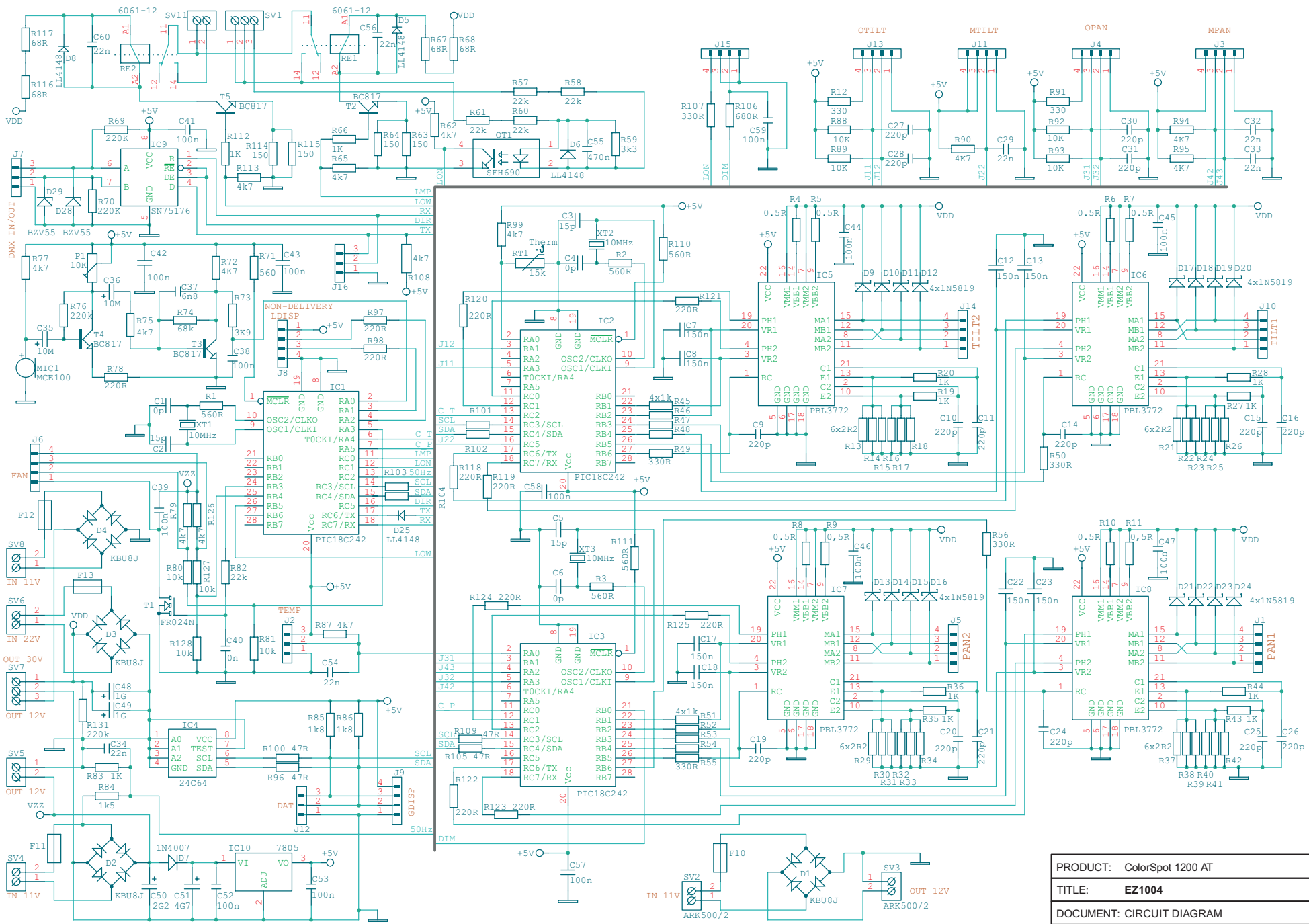

PRODUCT: ColorSpot 1200 AT		
TITLE: EZ1004		
DOCUMENT: CIRCUIT DIAGRAM		
VERSION: B	DATE: 6.11.2006	SHEET: 6 OF 8

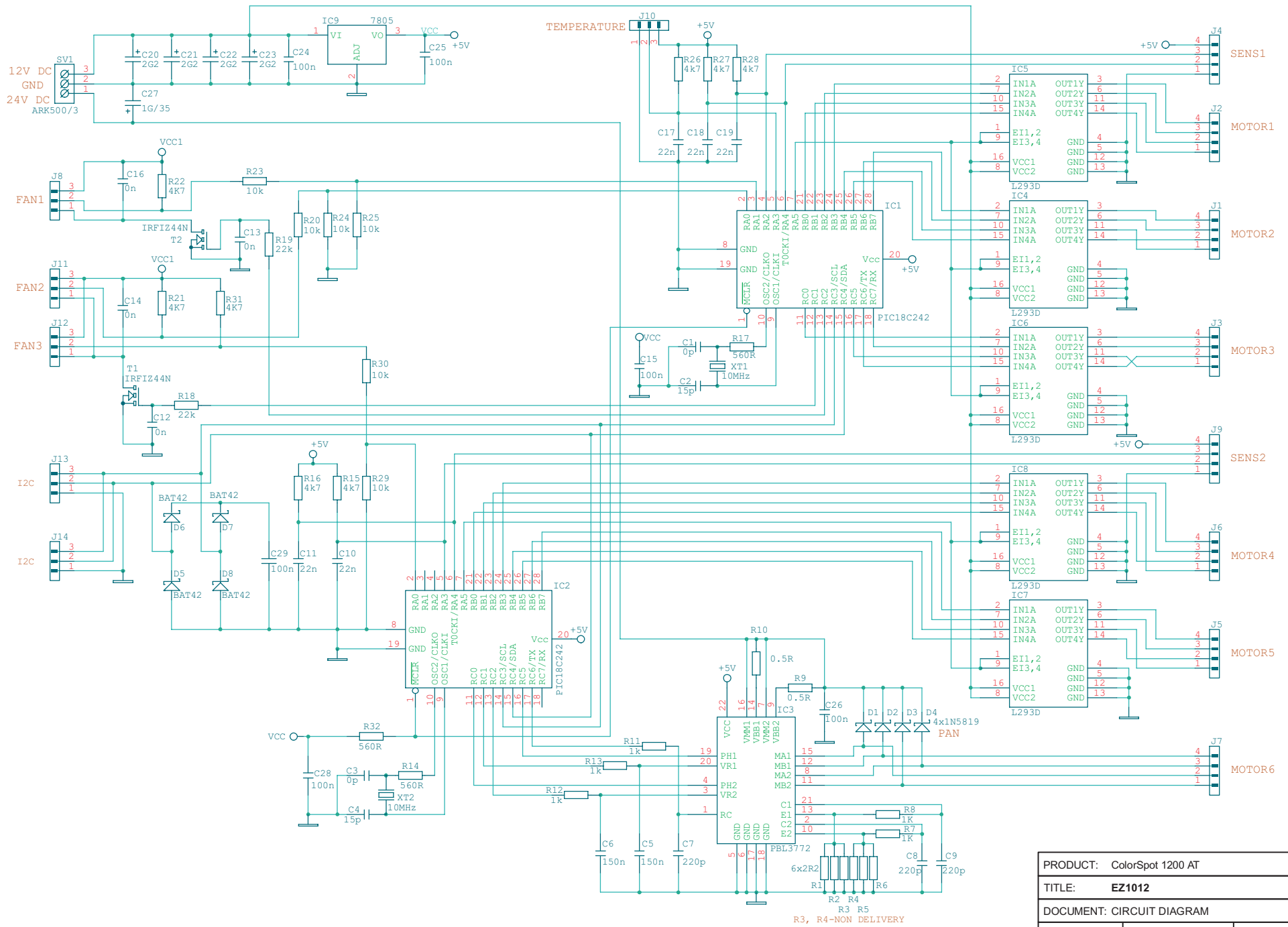

PRODUCT: ColorSpot 1200 AT		
TITLE: EZ1012		
DOCUMENT: CIRCUIT DIAGRAM		
VERSION: B	DATE: 6.11.2006	SHEET: 7 OF 8

R3, R4-NON DELIVERY

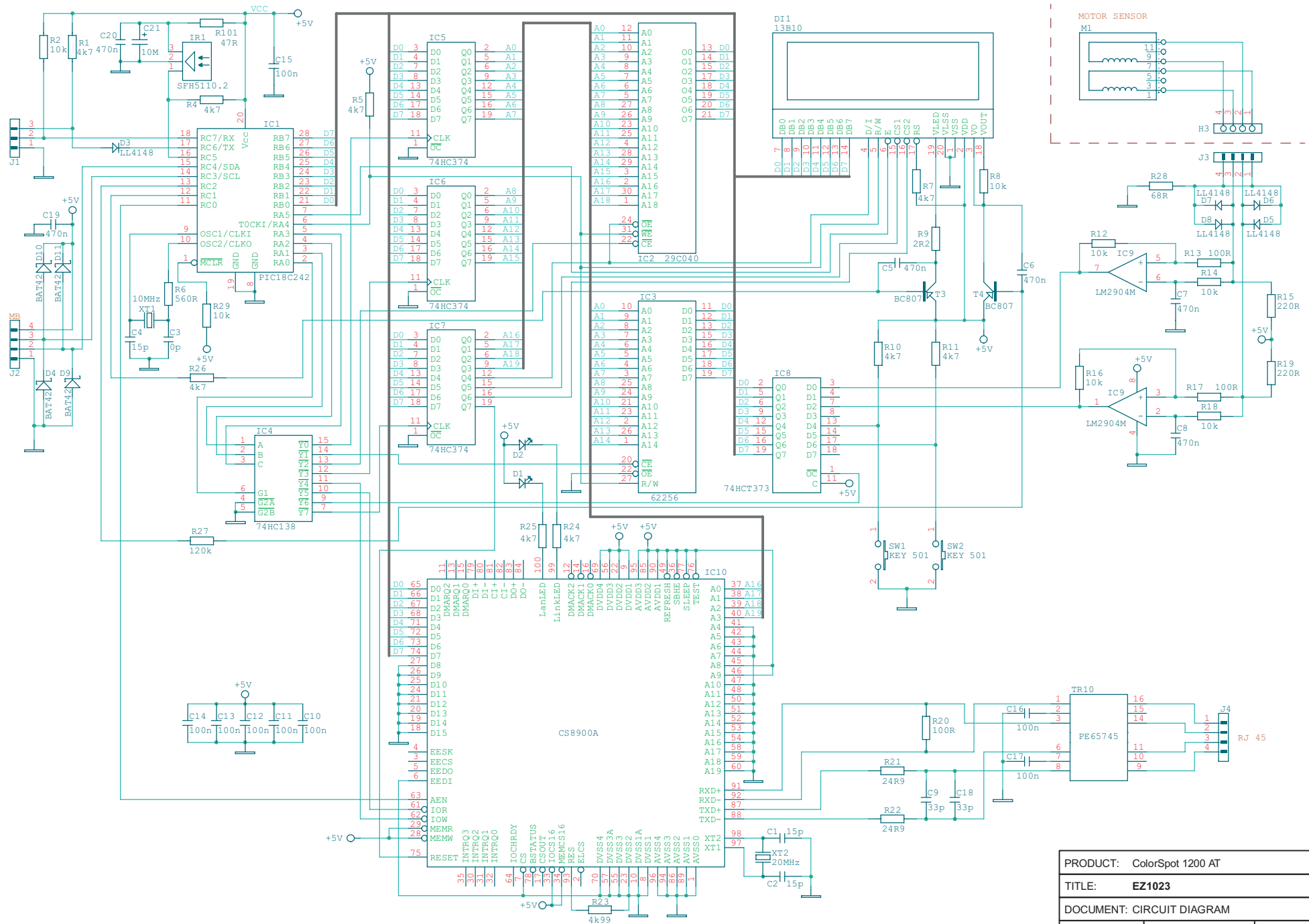

PRODUCT:	ColorSpot 1200 AT		
TITLE:	EZ1023		
DOCUMENT:	CIRCUIT DIAGRAM		
VERSION:	B	DATE:	6.11.2006
SHEET:	8 OF 8		